

P4

PodTrak

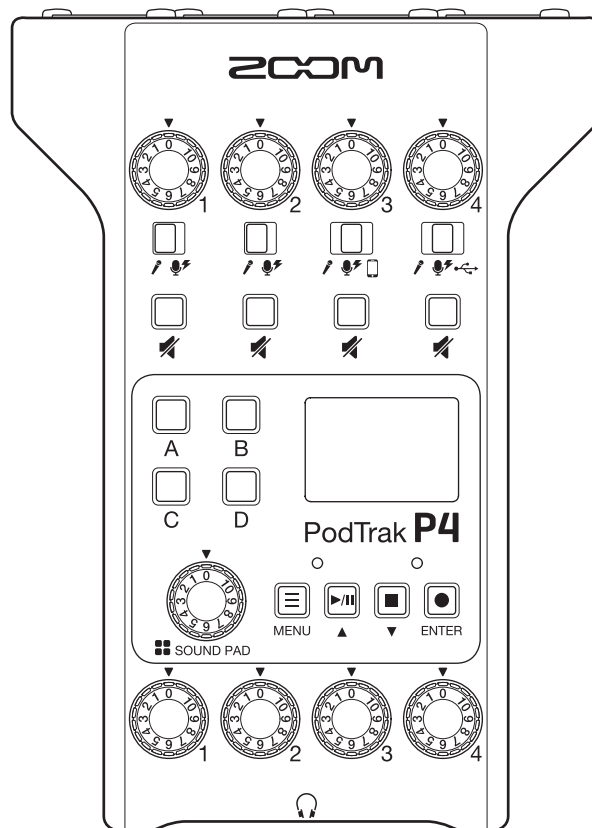

Operation Manual

You must read the Usage and Safety Precautions before use.

© 2021 ZOOM CORPORATION

Copying or reprinting this manual in part or in whole without permission is prohibited.

Product names, registered trademarks and company names in this document are the property of their respective companies. All trademarks and registered trademarks in this document are for identification purposes only and are not intended to infringe on the copyrights of their respective owners.

Proper display is not possible on grayscale devices.

Notes about this Operation Manual

You might need this manual in the future. Always keep it in a place where you can access it easily.

The contents of this document and the specifications of the product could be changed without notice.

- Windows® is a trademark and registered trademark of Microsoft® Corporation.
- iPadOS is a trademark or registered trademark of Apple Inc.
- iOS is a trademark or registered trademark of Cisco Systems, Inc. in the USA and other countries and is used under license.
- The SD, SDHC and SDXC logos are trademarks.
- Other product names, registered trademarks and company names in this document are the property of their respective companies.

Note: All trademarks and registered trademarks in this document are for identification purposes only and are not intended to infringe on the copyrights of their respective owners.

Recording from copyrighted sources, including CDs, records, tapes, live performances, video works and broadcasts, without permission of the copyright holder for any purpose other than personal use is prohibited by law. Zoom Corporation will not assume any responsibility related to infringements of copyrights.

Introduction

Thank you very much for purchasing the ZOOM **P4** PodTrak.

The **P4** is a multitrack recorder designed for podcasting. Even beginners can start recording high quality audio right away just by connecting mics and headphones. We also recommend the **P4** to veteran podcasters as a compact combination of useful recording functions. We hope you enjoy recording episodes in bedrooms, on café terraces and at all kinds of places.

Main features of the P4

Use your favorite mics for recording

The high-quality built-in mic preamps support not only dynamic mics but also condenser mics that require phantom power (+48 V). Enjoy recording using your favorite mics.

Multitrack recorder supports recording up to four channels at the same time

The levels of the 4 mic inputs can be adjusted for the voices of the participants. The 4 headphone outputs allow everyone participating to monitor the sound that is being recorded. In addition to a stereo file ready to be used for podcasting, the recorded data includes separate files for the audio of each channel that can be utilized for editing after recording.

Power options enable recording anywhere

In addition to using an AC adapter, the **P4** can be powered by 2 AA batteries or a USB mobile battery, enabling use outdoors and other places without power sources.

Remote recording

If all the podcasters cannot gather in one place or you want to invite guests who are far away, you can use smartphones and computers to enable remote participation in recording. A Mix Minus function prevents echoes from occurring in the audio of remote participants. By connecting an optional wireless adapter (BTA-2), smartphones can be connected wirelessly to the **P4**.

Instant playback of jingles and recorded interviews

The SOUND PAD section has 4 buttons that can be used for real-time playback of audio files, including built-in sounds. Make the most of this function to enhance your podcasts and live streams.

Live streaming

The 2-in/2-out USB audio interface functions of the **P4** can be used for live streaming and recording with computers, smartphones and tablets. Since it supports class compliant mode, installation of a dedicated driver is not necessary.

Optional accessory pack

We have prepared an optional Podcast Mic Pack with related accessories, including a dynamic mics (ZDM-1) and headphones (ZHP-1), along with software useful for editing on a computer after recording.

Contents

Notes about this Operation Manual	2	Transferring files to a computer, smartphone or tablet	31
Introduction	3	Transferring files to a computer, smartphone or tablet.....	31
Contents	4	P4 folder and file structure	32
Podcasting with the P4	5	Using SOUND PAD functions	33
P4 overview	6	Assigning audio files to SOUND PAD buttons	33
Functions of parts	6	Playing SOUND PAD buttons	34
Connection examples	9	Setting playback methods for each SOUND PAD.....	35
Use examples	10	Adjusting the levels of each SOUND PAD ...	37
Explanation of terms	11	Using as an audio interface	38
Signal flow	12	Connecting a computer, smartphone or tablet	38
Home Screen overview.....	13	Inputting USB audio return on channel 4 ...	39
Basic Menu Screen operations	13	Setting USB Mix Minus	40
Making preparations	14	Modifying the date and time	41
Inserting SD cards	14	Setting the type of batteries used	42
Providing power	15	Adjusting the display contrast	43
Turning the power on	16	Setting the Auto Power Off function	44
Setting the date and time (first time starting up)	17	Testing SD cards	45
Connecting	18	Formatting SD cards	49
Connecting mics.....	18	Restoring factory default settings	50
Connecting headphones	19	Updating the firmware	51
Connecting smartphones	20	Error message list	52
Connecting a BTA-2 (dedicated wireless adapter).....	21	Troubleshooting	54
Connecting a computer, smartphone or tablet by USB	22	General	54
Recording	23	Audio interface	55
Adjusting input levels	23	Specifications	56
Making mic settings (Mic Settings)	24		
Recording	25		
Playing recordings	26		
Playing recordings	26		
Selecting files and playing them	27		
Changing the names of recorded files	29		
Deleting files	30		

Podcasting with the P4

1. Prepare and confirm connections

● Preparation

Install an SD card in the **P4**, provide it power, and set the date and time.

● Connecting and checking

Connect microphones and headphones.

- By using a single mic for each person, levels can be adjusted to suit each voice, enabling clear recording of all voices.
- Adjust the distance between the participants and their mics and set each of their input levels according to their volumes so that they can be recorded at stable levels.
- Mute input channels that are not being used to prevent noise from being picked up.
- Headphones are necessary to not only confirm the inputs from the mics, but also to hear the sounds of SOUND PAD playback and the voices of guests participating remotely.

If a guest in a distant location is participating remotely in recording, connect the **P4** to a computer, smartphone or tablet.

- The smartphone connector is designed to prevent echo when used. When using the USB port for this, turn on USB Mix Minus.

Confirm the levels and other settings of the SOUND PAD buttons, which can be used for one-touch playback of background music, jingles and other sounds during recording.

● Countermeasures for environmental noise in recording locations

- Attaching windscreens to mics can reduce noise caused by wind blowing. Adjust the directions of mics so that they do not point toward other sources of environmental noise.
- Touching mics and power cables during recording could result in handling noise that sounds like crackling. Use mic stands and put cables in order beforehand. Placing mic cables and power cables too close together can result in noise being picked up.
- Enabling the Lo Cut function in the **P4** Mic Settings menu can reduce the amount of vibration, wind and other noise picked up by mics.

2. Record

● Recording theme

To enable recording conversations at a good pace, confirm the content of the discussion with the other participants and prepare reference materials and other resources so that they are at hand.

● Speaking tips

Try to speak clearly while avoiding making sibilant (hissing s) and plosive (p and d) sounds too loud.

● SOUND PAD buttons

Use these to add excitement to programs with jingles and effects.

3. Publish

● Publish

The File Transfer menu can be used to connect to a computer, smartphone or tablet and transfer recorded files. Upload them to the podcasting service* or server you are using.

*Services that provide servers for saving podcast files

● Editing before publish

Using audio mastering software, for example, to adjust periods of silence and to add effects could enhance the podcast.

The files recorded for each channel by the **P4** are perfect for mixing in a DAW.

P4 overview

Functions of parts

■ Top

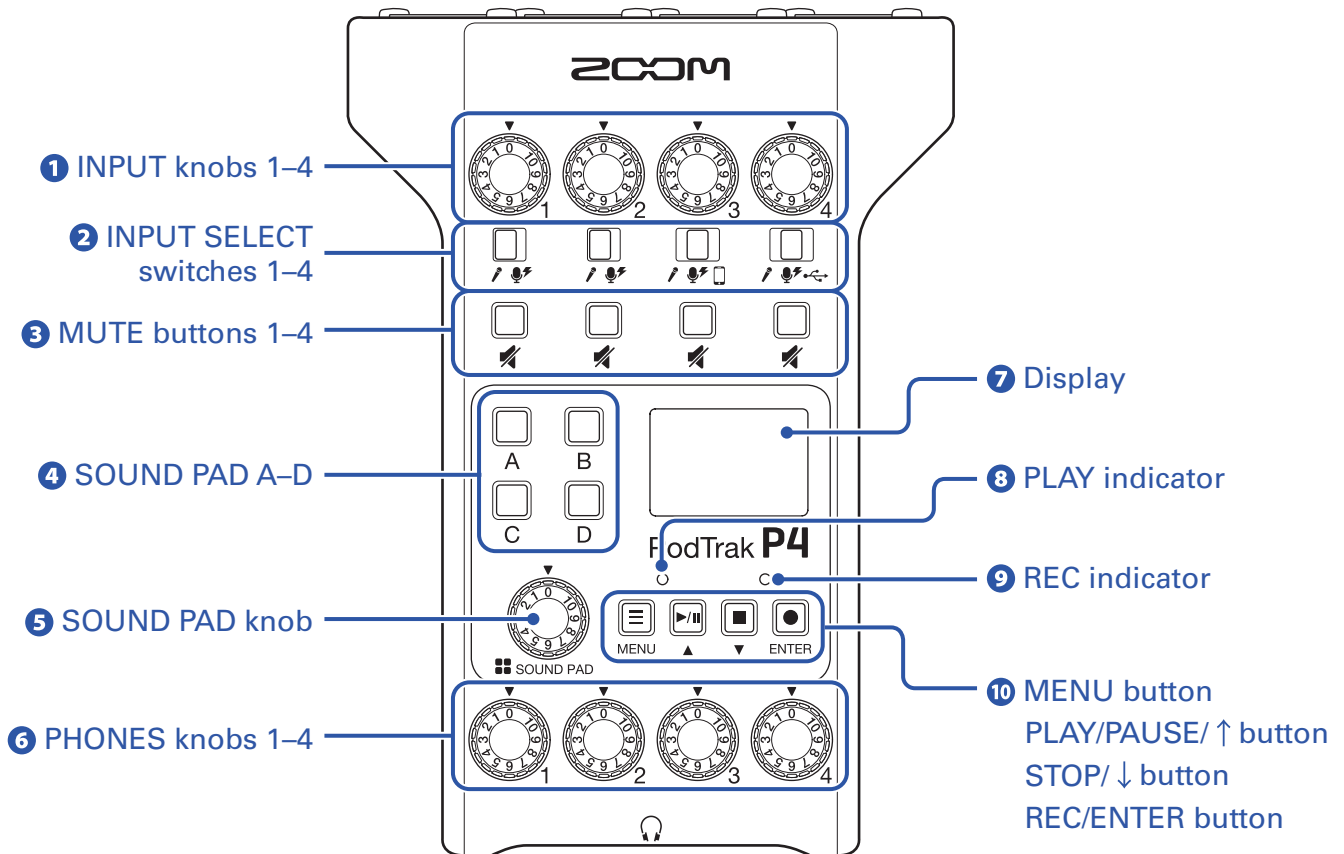





1 INPUT knobs 1-4

Use to adjust input signal levels.

2 INPUT SELECT switches 1-4

Set these according to the connected equipment.

-  Dynamic mic
-  Condenser mic (supplies +48 V phantom power)
-  Smartphone, etc.
-  USB audio return signal output from computer, smartphone or tablet

3 MUTE buttons 1-4

Use to mute (lit) and unmute (unlit) signals.

4 SOUND PAD A-D

Use these to play the sounds assigned to them.

5 SOUND PAD knob

Use to adjust SOUND PAD levels.

6 PHONES knobs 1–4

Use to adjust the volumes of signals output from PHONES jacks 1–4.

7 Display

This shows the recorder status and Menu Screen.

When the **P4** is running on battery power, the display will automatically dim if it is not operated for 15 seconds. Operating the unit will restore the display to its normal brightness.

8 PLAY indicator

This lights during playback and blinks when paused.

9 REC indicator

This lights during recording and blinks when recording is paused.

10 MENU button

Use to open the Menu Screen and to return to the previous screen.

PLAY/PAUSE/ ↑ button

Use to play/pause recorded files.

Use to move the cursor up on the Menu Screen.

STOP/ ↓ button

Use to stop recording/playback.

Use to move the cursor down on the Menu Screen.

REC/ENTER button

Use to start/stop recording.

Use to confirm a selection on the Menu Screen.

■ Back/front

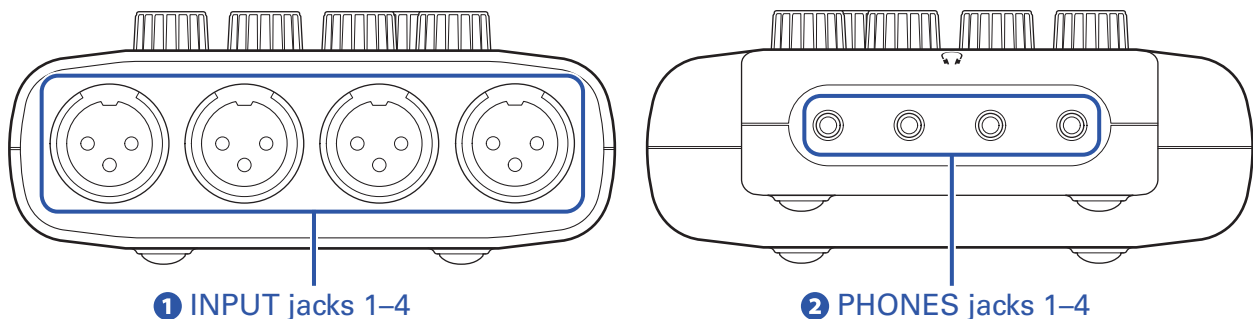

1 INPUT jacks 1–4

These input jacks have built-in mic preamps.

2 PHONES jacks 1–4

These output the signals adjusted by PHONES knobs 1–4.

■ Left/Right

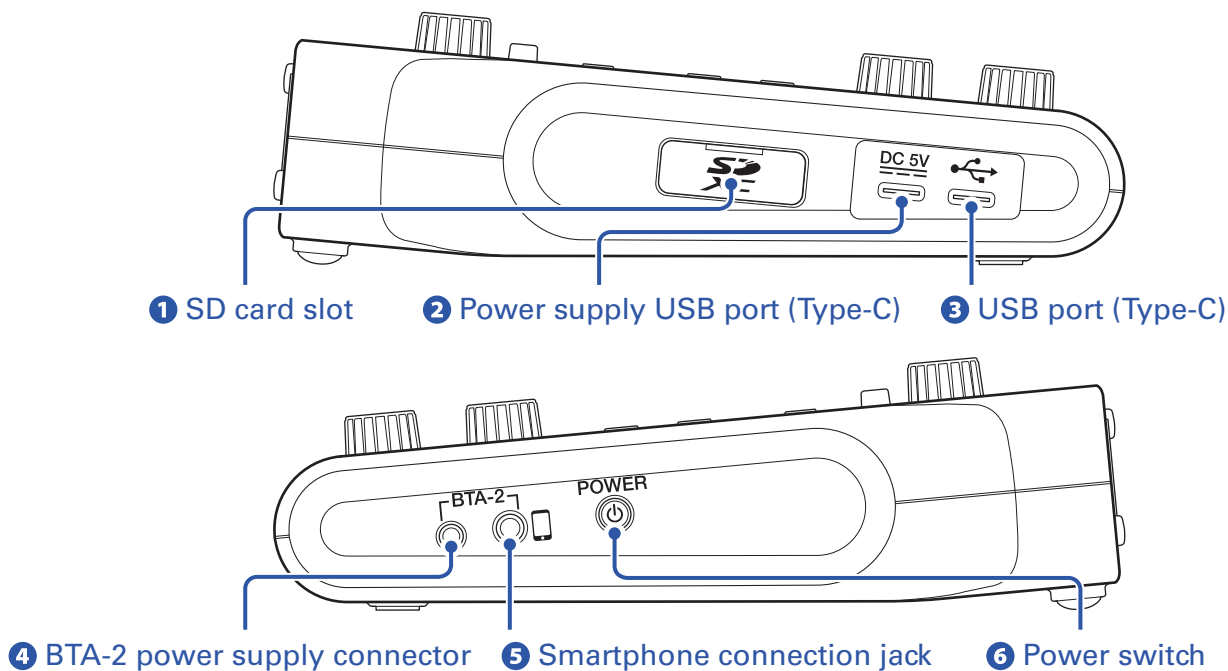

1 SD card slot

Cards that conform to SDHC and SDXC specifications are supported.

Format the SD card with the **P4** before use. (→ [“Formatting SD cards” on page 49](#))

2 Power supply USB port (Type-C)

This power supply USB port is for connecting an AC adapter or portable battery.

3 USB port (Type-C)

This USB port is for connecting with a computer, smartphone or tablet.

4 BTA-2 power supply connector

Use this power supply connector when connecting a BTA-2 wireless adapter.

5 Smartphone connection jack

By using a 4-contact mini-plug cable, the signal from a smartphone can be input on channel 3 while the signal mixed on the **P4** (excluding the channel 3 signal) is returned to the smartphone simultaneously.

6 Power switch

This turns the power on and off.

Connection examples

Mics

Dynamic and condenser mics

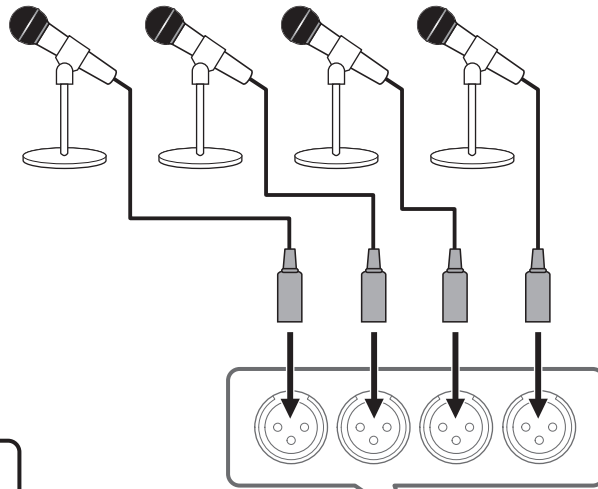

AC adapter
(ZOOM AD-17)

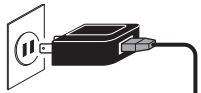

USB Type-C
port

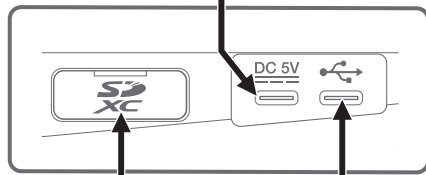

SD card

USB Type-C
port

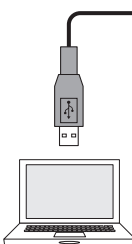

Smartphone

Guests can participate in podcasts by phone.

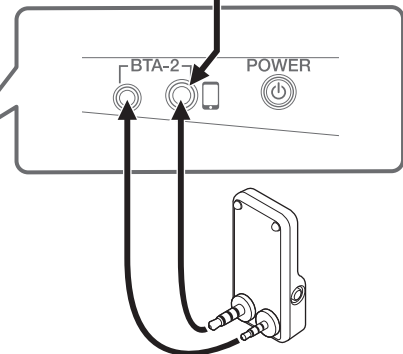

Wireless adapter (ZOOM BTA-2)

This enables wireless connection to smartphones and tablets.

Computer, smartphone or tablet

Using the audio interface function, audio can be shared with a computer, smartphone or tablet, and recordings on the SD card can be transferred for editing.

This might not be usable with some communication apps.

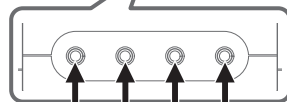

Headphones

Use examples

Using on location

By using the **P4** with batteries or a portable battery, audio can be recorded on location. The recorded audio is saved on an SD card and can be transferred to a computer, smartphone or tablet for editing and distribution.



Using for live streaming

By connecting a **P4** to a computer, smartphone or tablet, you can use it to stream audio in real time.



Explanation of terms

Audio interface

The **P4** enables sounds from mics and instruments, for example, to be input to a computer, smartphone or tablet. It can also output sounds from that device to speakers and headphones.

USB audio return

When the **P4** is connected as an audio interface, this is the signal output from the computer, smartphone or tablet. Background music can be played from the connected device.

SOUND PAD buttons

Audio files can be assigned to these. Press one to play the assigned file. These are convenient to play opening and closing music, jingles, and interviews that have been recorded in advance.

USB Mix Minus

When using the **P4** as an audio interface, this can prevent feedback to a person participating in a call through the connected device.

Podcasting

This is one way to share audio files publicly on the Internet. Podcasters make contents and distribute them via the Internet so people can listen easily on smartphones, computers and other devices.

Dynamic mic

This type of mic does not require phantom power and is strong and durable.

Condenser mic

This type of mic usually has high sensitivity and can capture audio with high quality. Phantom power supply is necessary for use.

Signal flow

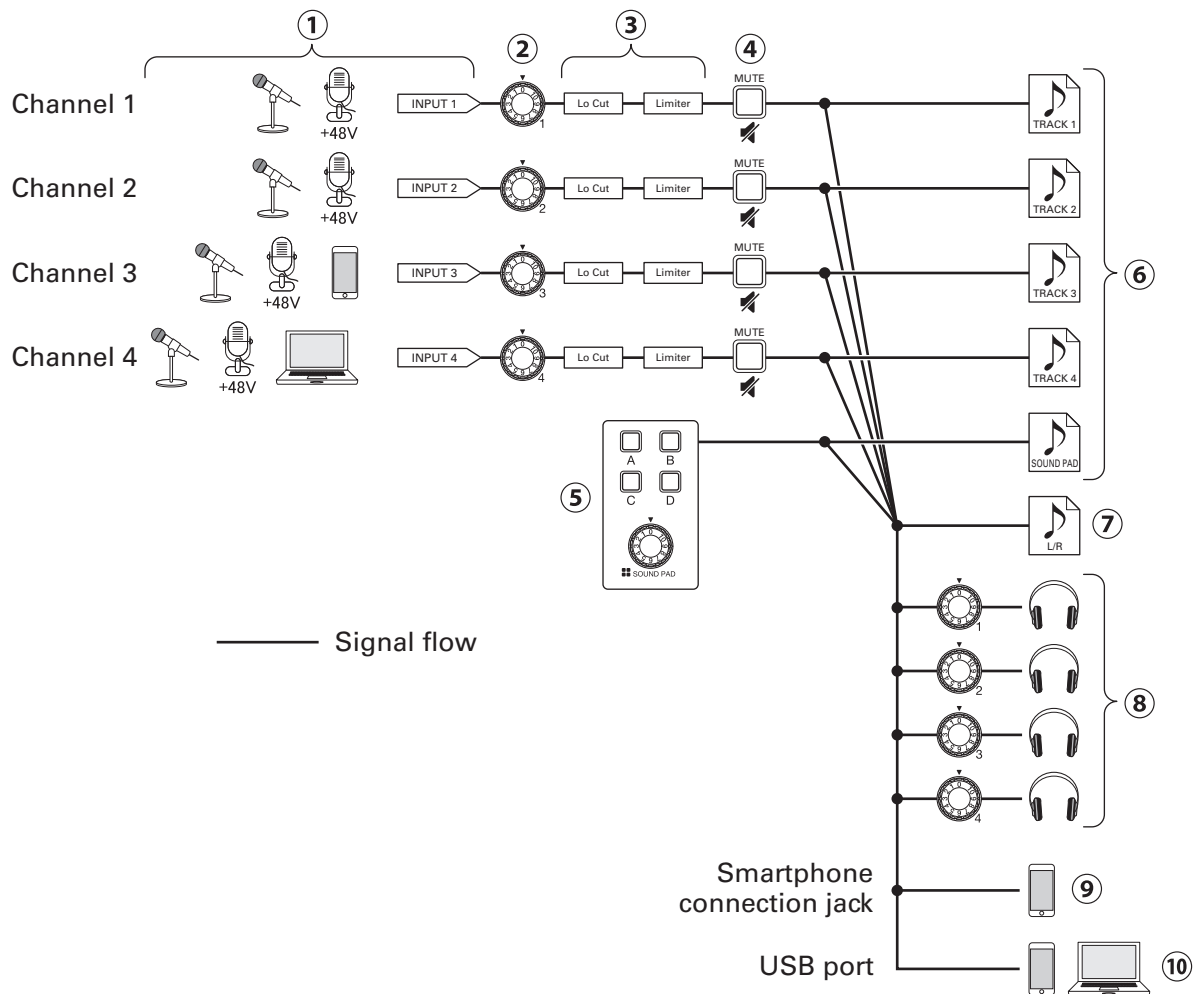

Home Screen overview

This screen appears on the display when the **P4** power is turned on.

This shows the **P4** conditions, including recording status and input levels.

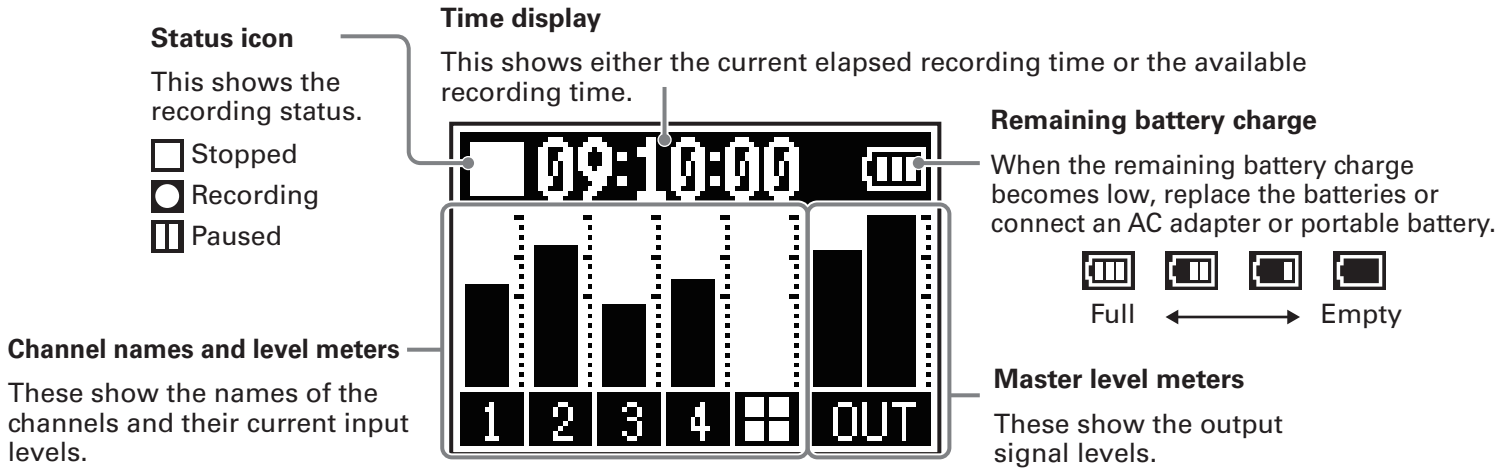

Basic Menu Screen operations

Use the Menu Screen to make settings, including for recording and the SOUND PAD buttons.

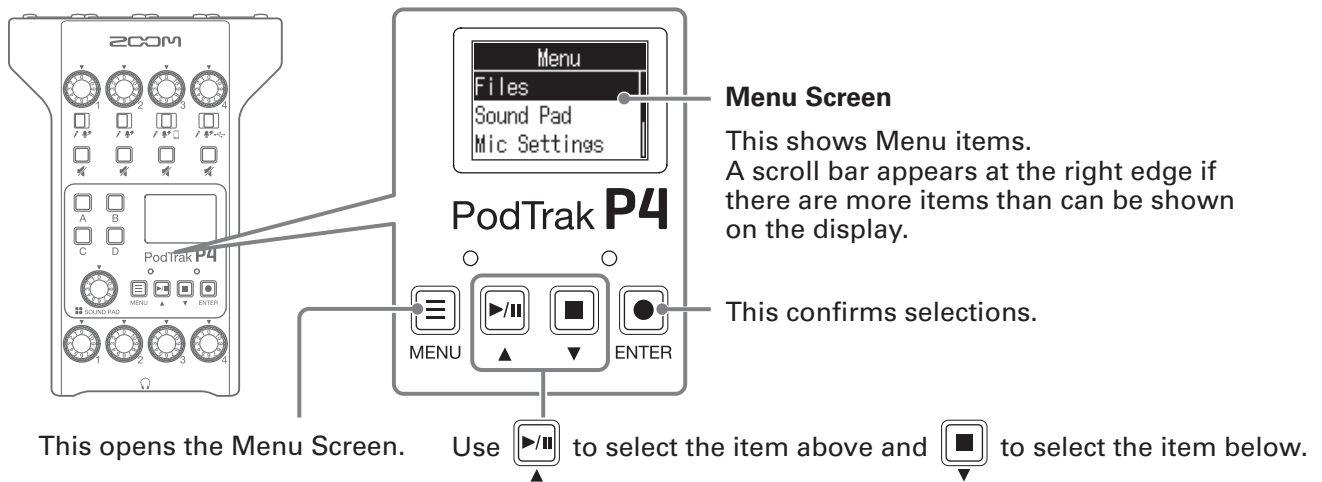

In this Operation Manual, Menu item names are shown with a gray background. (Example: **Files**)

On the Menu Screen, press **▶/||** to select the item above, and press **■** to select the item below. Press **ENTER** to confirm the selected item.

■ Returning to the Home Screen

To return to the Home Screen, press **MENU** repeatedly until it appears.

■ Returning to the previous screen

Press **MENU** to return to the previous screen.

Making preparations

Inserting SD cards

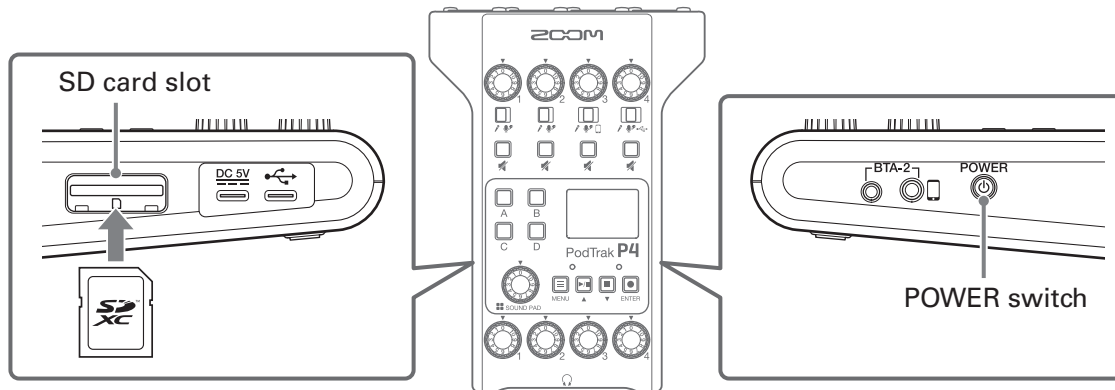

1. With the power off, open the SD card slot cover, and insert an SD card all the way into the slot. To remove an SD card, push it further into the slot and then pull it out.

NOTE

- Cards that conform to SDHC and SDXC specifications are supported.
- Disable write-protection on the SD card before inserting it.
- Inserting or removing an SD card while the power is on could result in data loss.
- When inserting an SD card, be sure to insert the correct end with the top side up as shown.
- If an SD card is not loaded, recording and playback are not possible.
- Before using SD cards that have just been purchased or that have been formatted on a computer, they must be formatted by the **P4** (→ [“Formatting SD cards” on page 49](#)).

Providing power

Installing batteries

To run the **P4** on battery power, open the battery compartment cover on the bottom and install two AA batteries.

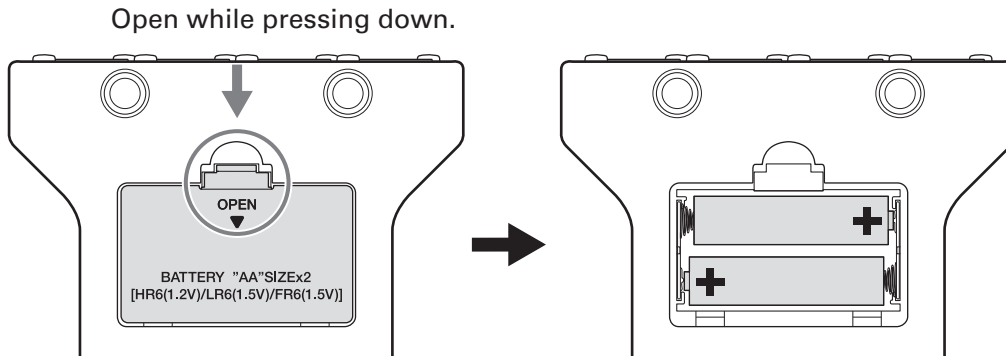

NOTE

- Use only one type of battery (alkaline, NiMH or lithium) at a time.
- Set the type of battery used correctly so that the amount of remaining battery charge can be shown accurately. (→ [“Setting the type of batteries used” on page 42](#))
- The battery charge can be checked on the Home Screen (→ [page 13](#)).

Other power sources

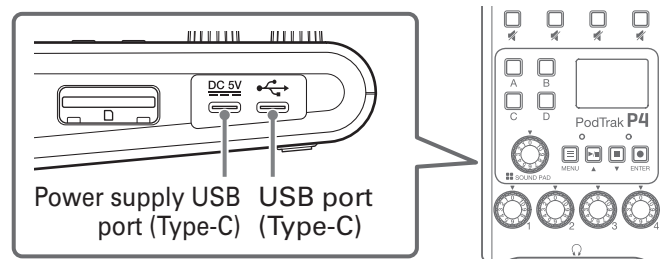

■ Using the power supply USB port (Type-C)

Connect the dedicated AC adapter (AD-17) or a mobile battery to the power supply USB port (Type-C).

■ Using the USB port (Type-C)

By connecting this USB port (Type-C) to a computer, the **P4** can be operated on USB bus power.

NOTE

- By connecting this USB port to a computer before turning the power on, the **P4** can be operated on USB bus power.
- After turning the power on, if the USB cable connected to the USB port (Type-C) is disconnected and reconnected, the **P4** cannot be operated on USB bus power until it is restarted, even if connected to a computer.
- If a smartphone or tablet is connected to this USB port, depending on the device, turning the **P4** power on might not be possible. In this case, connect an AC adapter or mobile battery to the USB port, or install batteries in the battery compartment on the bottom of the unit to use it.

Turning the power on

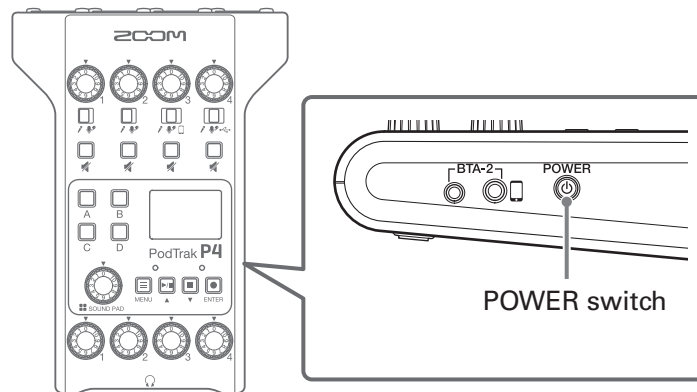

1. Press  until "ZOOM" appears on the display.

This turns the power on and opens the Home Screen.

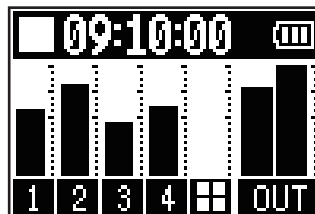

The first time the power is turned on after purchase and after the **P4** has been restored to its factory default state, set the date and time when the Set Date/Time setting screen opens. (→ ["Setting the date and time \(first time starting up\)"](#) on page 17)

NOTE

The power will automatically turn off if it is not used for 10 hours. To keep the power on at all times, disable the automatic power saving function. (→ ["Setting the Auto Power Off function"](#) on page 44)

Turning the power off

1. Press  until "Goodbye! See You!" appears on the display.

NOTE

When the power is turned off, the current settings are saved on the **P4**.

HINT







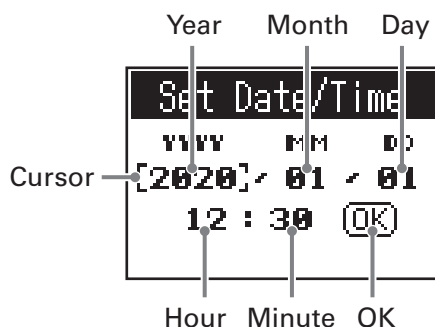

When the power is turned on, it will start up in the state it was in when last turned off.

Setting the date and time (first time starting up)

The first time the power is turned on after purchase, set the date and time when the Set Date/Time setting screen opens.

The date and time are stored in recorded files, and the recording start date/time is used in the file name. Having the correct date and time set is helpful when looking for files, for example, by allowing contents to be determined by names.



1. Press  /  to move the cursor to the item you want to set, and press .
2. Use  /  to change the value, and press  to confirm.
3. Repeat steps 1 and 2 to set the date and time.
4. After setting the date and time, use  /  to select OK, and press .

This confirms the set date and time and reopens the Home Screen.

HINT

The date and time setting can also be changed later from the Menu Screen. (→ [“Modifying the date and time” on page 41](#))

Connecting

Connecting mics

Connect mics to capture sound. Up to 4 mics can be connected.

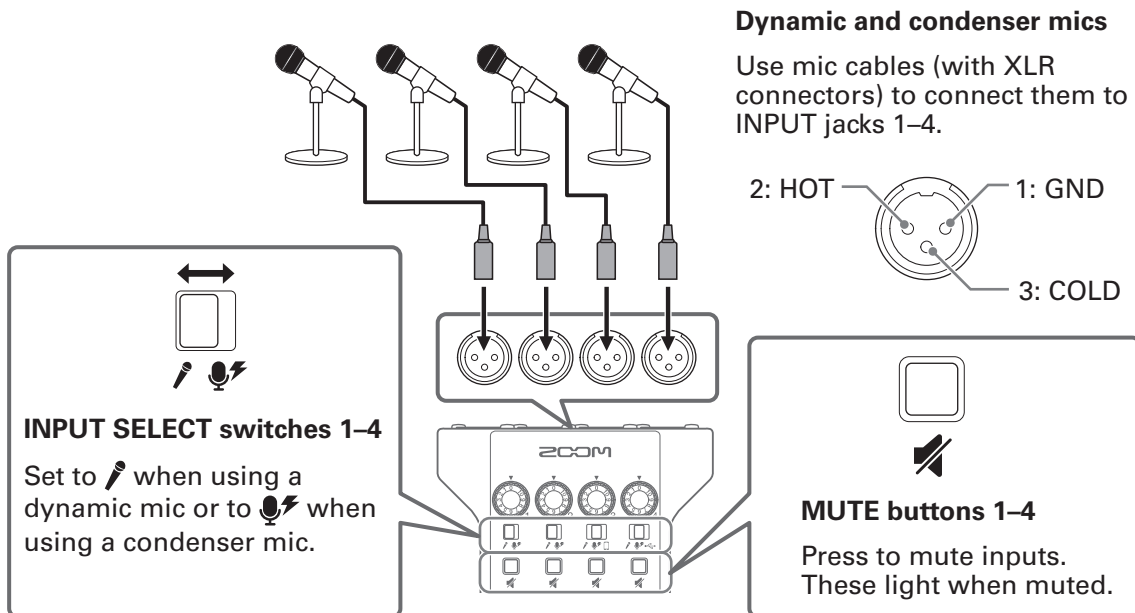

NOTE

- When an INPUT SELECT switch is set to , +48V phantom power is supplied to that INPUT jack. When connecting to a device that is not compatible with phantom power, do not set the INPUT SELECT switch to . Doing so could damage the device.
- During recording, operating the INPUT SELECT switch will not change the phantom power supply setting. The change will be applied after recording completes.

Connecting headphones

Connect headphones to check the sound. The PHONES 1-4 jacks output the master channel sound. Up to 4 pairs of headphones can be connected.

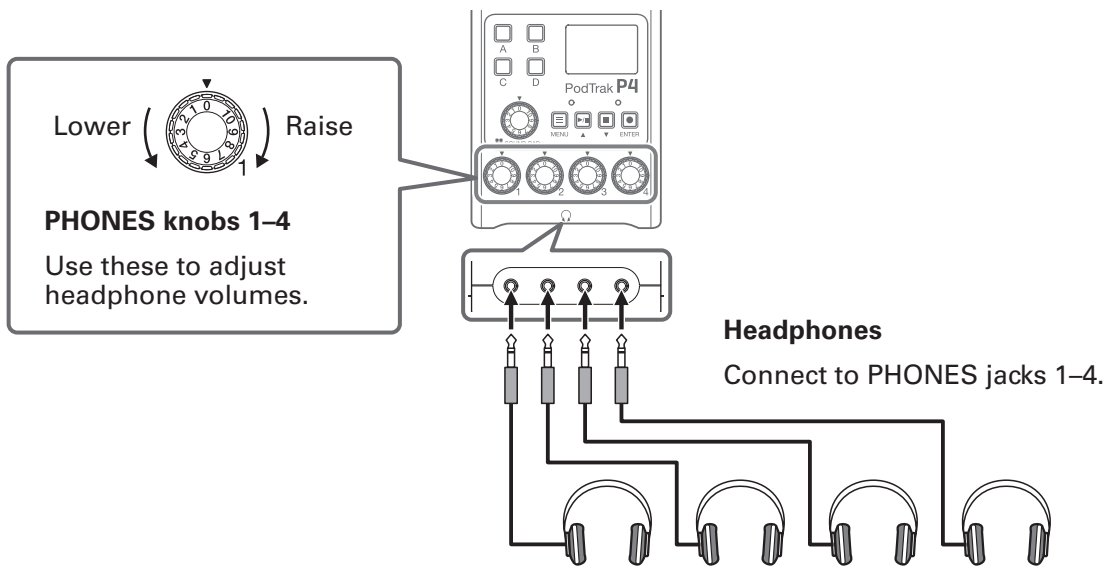

Connecting smartphones

The following operations are possible when a smartphone is connected to the smartphone connection jack.

- When podcasting, the voice of a guest participating by phone can be input on channel 3. By using a 4-contact mini-plug cable, a signal can be input from a smartphone and a mono signal can be sent back to it simultaneously. Since this output signal does not include the sound from channel 3, guests participating by phone will not have an echo.
- Music played back on a smartphone can be input on channel 3.

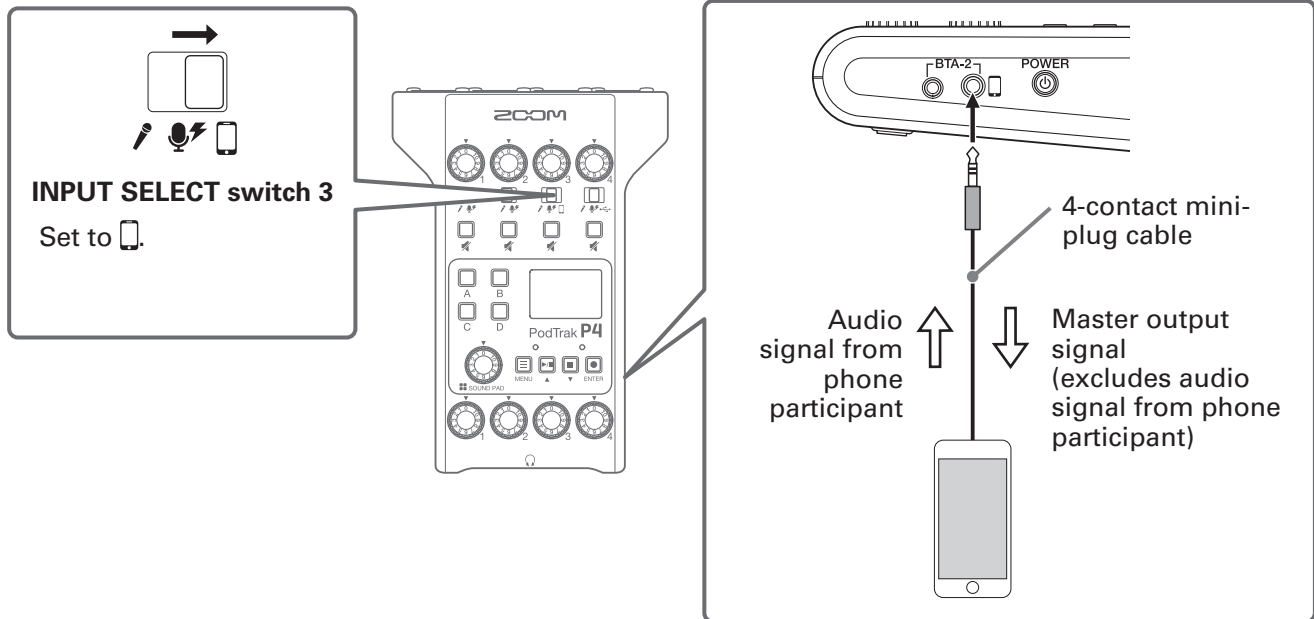

4-contact mini-plug

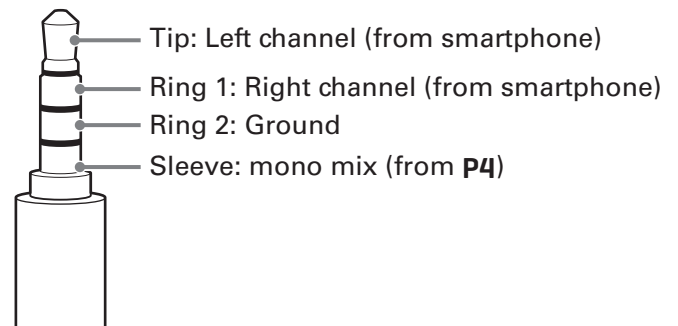

Connecting a BTA-2 (dedicated wireless adapter)

By connecting a BTA-2, audio can be input through the smartphone connection jack via Bluetooth.

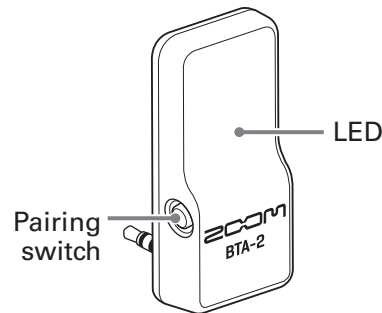

Connecting

Pairing must be conducted the first time connecting.

1. While the **P4** power is off, connect the BTA-2 to the smartphone connection jack and the BTA-2 power supply connector.

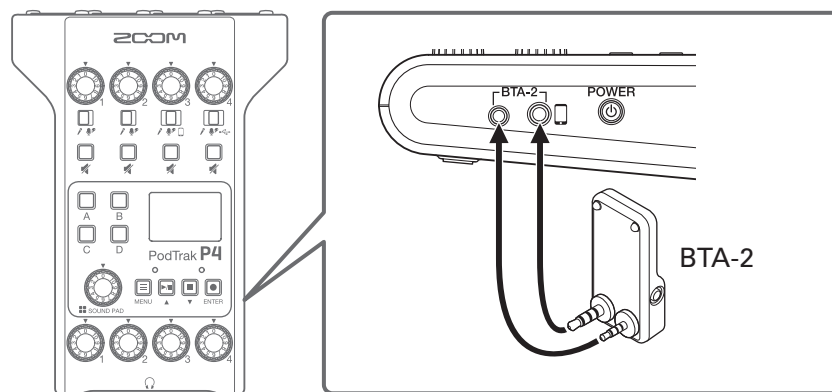

2. Turn the **P4** power on (→ [“Turning the power on” on page 16](#)).
The LED lights white when power is being supplied to the BTA-2.
If a smartphone has already been paired, it will automatically be connected at this time.
3. Press and hold the pairing switch until the BTA-2 LED blinks white.
This puts the BTA-2 into connection standby.
4. Conduct connection procedures on the smartphone.
The LED will light blue when connection completes.

NOTE

When connecting to a smartphone using a BTA-2, set INPUT SELECT switch 3 to .

Disconnecting

1. Conduct disconnection procedures on the smartphone.
This disconnects it.
2. The **P4** power should be off when disconnecting a BTA-2.

Connecting a computer, smartphone or tablet by USB

The following operations are possible when a computer, smartphone or tablet is connected to the USB port (Type-C).

- Using the audio interface function (→ [page 38](#)), music, interviews and other audio from a computer, smartphone or tablet can be input through channel 4. Sound input through the **P4** and sounds played with SOUND PAD buttons can also be sent back to that device and streamed live directly.
- Recording files on SD cards can also be transferred to a computer for editing. (→ [“Transferring files to a computer, smartphone or tablet” on page 31](#))

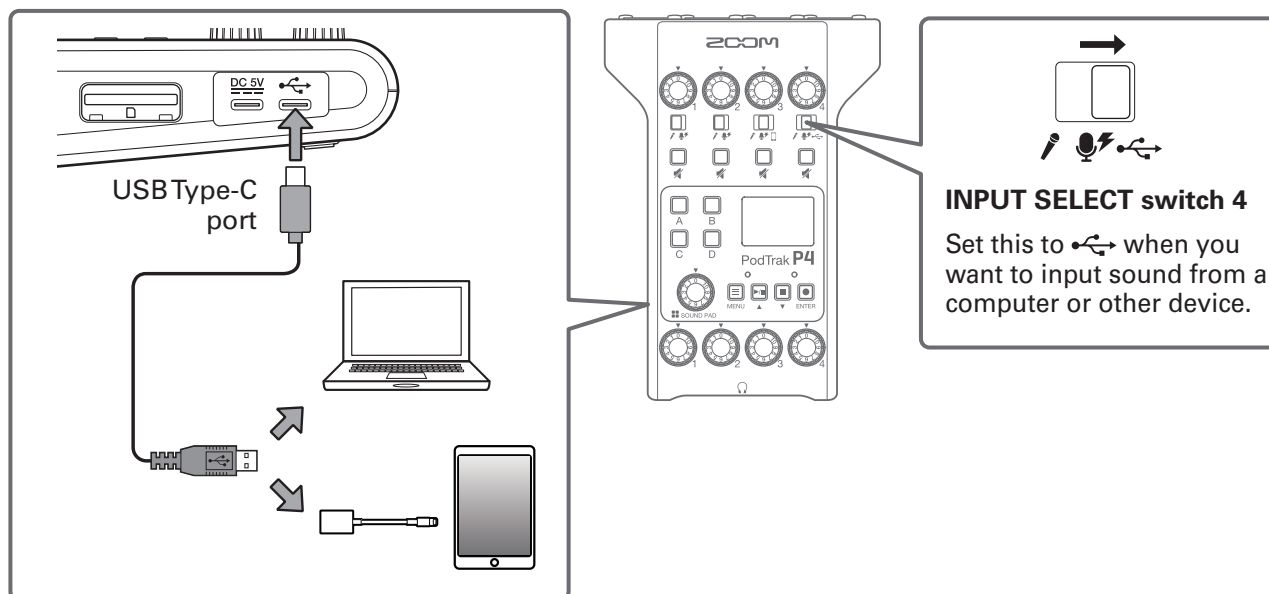

NOTE

Use a Lightning to USB Camera Adapter (or Lightning to USB 3 Camera Adapter) to connect to an iOS/iPadOS device with a lightning connector.

Recording

Adjusting input levels

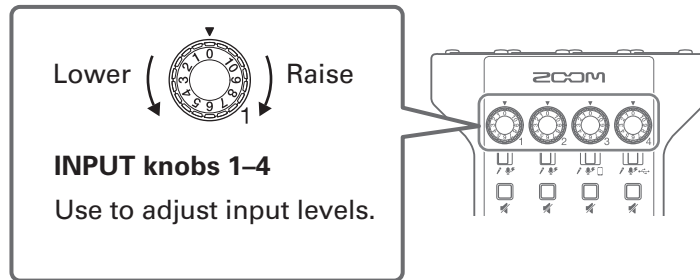

Adjust input levels so that the volumes of the mics being recorded neither cause distortion nor are too low.

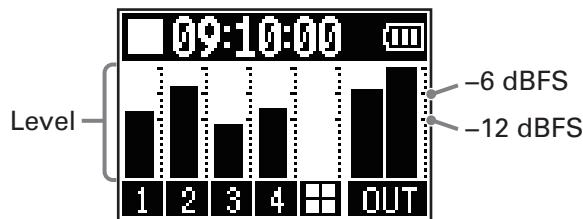

Input levels are shown on the display. While balancing the mix of the channels, adjust their levels so that they are between -12 dBFS -6 dBFS.



HINT

- The level increases when the mic and the speaker's mouth are close and decreases when they are far apart. When recording, maintain the same distance between the mic and the speaker's mouth that was used when the input level was adjusted. (The standard distance between mic and mouth is 10–20 cm.)
- If smartphone or USB audio return signals are being input (INPUT SELECT switches set to  or ) , those channels will be in stereo and stereo level meters will be shown.

Making mic settings (Mic Settings)



The **Lo Cut** and **Limiter** functions can be turned on/off for each input. By default, they are on.

1. Press .

This opens the Menu Screen.

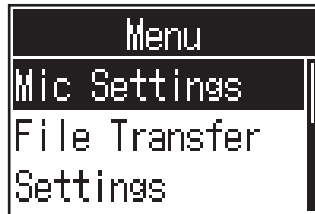
2. Use / to select **Mic Settings**, and press .



3. Use / to select the setting, and press .



- **Lo Cut**: This can cut low frequencies to reduce the sound of air conditioning, wind, vocal pops and other noise.
- **Limiter**: This can prevent distortion by reducing input signals that have excessively high levels.

4. Use / to select the mic (**Mic 1–Mic 4**) to set, and press .

Pressing  toggles the setting on and off.

The Lo Cut or Limiter setting is on for the mics that have check marks.

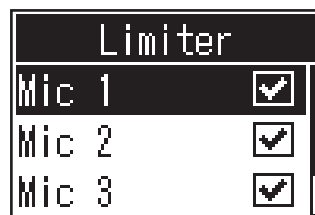
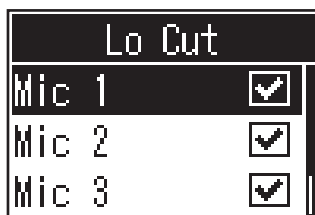

Recording

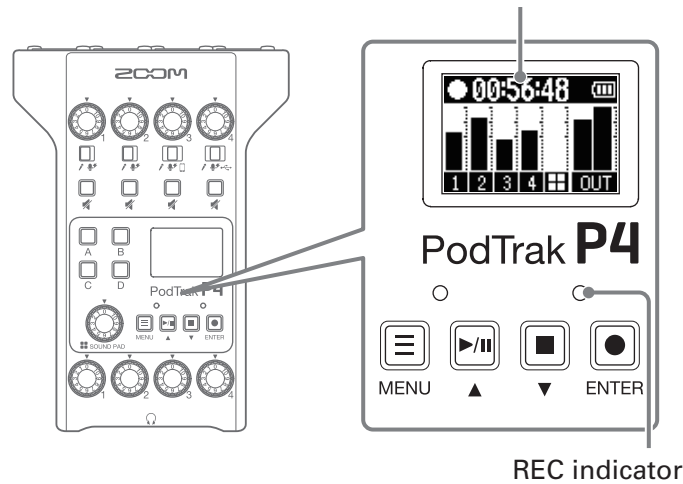

The input signals of each channel, the sounds (stereo) played by pressing SOUND PAD buttons, and the master channel signal (stereo) can be recorded simultaneously as separate files to the SD card.

Recording/recording paused: elapsed recording time
Recording stopped: available recording time



1. Press  when the Home Screen is open.



Recording will start and the REC indicator will light red.

Press  when recording to pause recording. (The REC indicator will blink). Press  again to resume recording.

2. Press  or .

Recording will stop.

HINT

- When the channel 3 INPUT SELECT switch is set to  or the channel 4 INPUT SELECT switch is set to , those channels will record in stereo.
 - If you do not want to record a channel or you want to turn its input off temporarily, press  to mute it.
 - Recorded files will be named with the date and time when recording started.
 - See [“P4 folder and file structure” on page 32](#) for the location where recorded files are saved.
-

Playing recordings

Playing recordings

Recorded files can be played back.

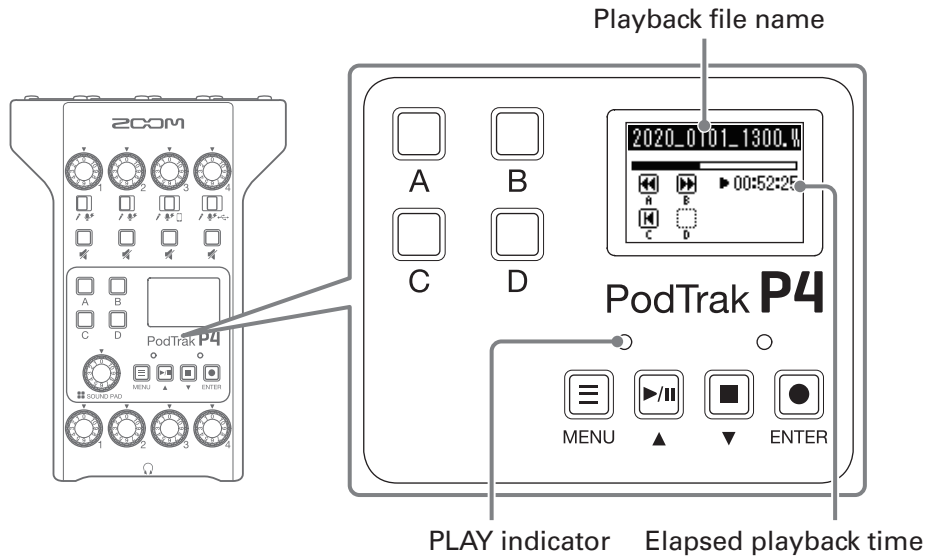







1. Press  when the Home Screen is open.

The most recently recorded file will start playing, the Playback Screen will open on the display, and the PLAY indicator will light green.

HINT

To select a file and play it back, see [“Selecting files and playing them” on page 27.](#)

Operations during playback



Function	Operation
Pause	Press  to start/pause playback alternately.
Search backward	Press and hold  .
Search forward	Press and hold  .
Skip to beginning	Press  to return to the file beginning.
Stopping playback	Press  or  to stop playback.

Selecting files and playing them



Files that have been recorded by the **P4** or that are saved on the SD card can be selected and played.

1. Press .

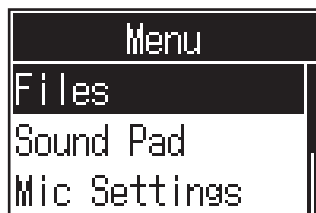

This opens the Menu Screen.

2. Use / to select **Files**, and press .



3. Use / to select the file you want to play, and press .



4. Use / to select **Play**, and press .



This opens the Playback Screen on the display and starts playback of the selected file.

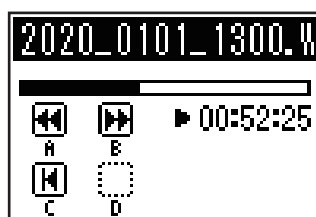

During playback, the PLAY indicator will light green.

See [“Operations during playback” on page 26](#) for operations during playback.

Selecting files not supported by the P4

When a file that is not supported by the **P4** is selected on the Files Screen, one of the following messages will be shown on the display.

■ File selected that cannot be played by the P4

MESSAGE
Choose 44.1kHz
or 48kHz File!

MESSAGE
Choose 16-bit
or 24-bit File!

MESSAGE
Choose WAV
or MP3 File!

MESSAGE
Choose Mono
or Stereo File!

If one of the above pop-up messages appears, the selected file cannot be played by the **P4**. Select a different file.

■ File selected that can be converted by the P4

MESSAGE
File Convert.
48kHz->44.1kHz

MESSAGE
File Convert.
24-bit->16-bit

MESSAGE
File Convert.
MP3->WAV



If one of the above pop-up messages appears, the selected file can be converted by the **P4** and then played. Select **Execute** to start conversion. The converted file will appear on the Files Screen.

Changing the names of recorded files



The names of files recorded by the **P4** can be changed.

1. Press .

This opens the Menu Screen.

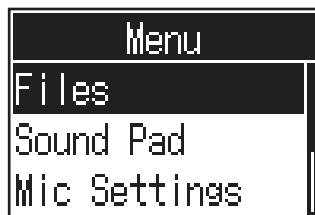
2. Use / to select **Files**, and press .



3. Use / to select the file with the name you want to change, and press .





4. Use / to select **Rename**, and press .

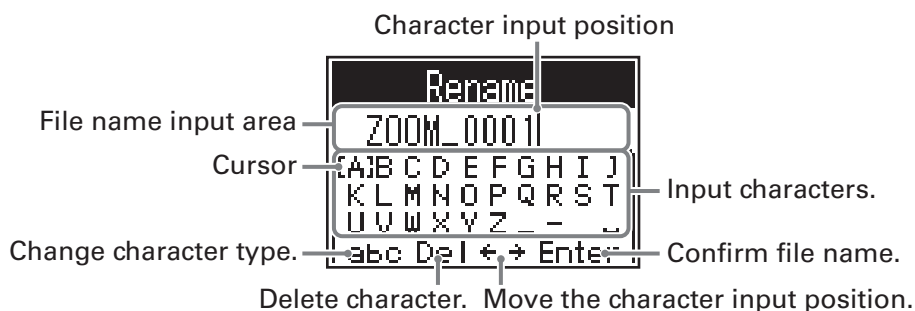

5. Change the file name in the file name input area.



- /: Move cursor left/right
- : Confirm

Deleting files



You can delete files that you do not need.

1. Press .

This opens the Menu Screen.

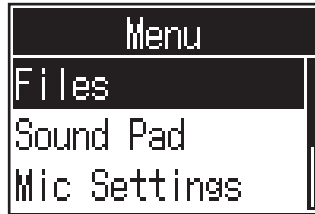
2. Use / to select **Files**, and press .



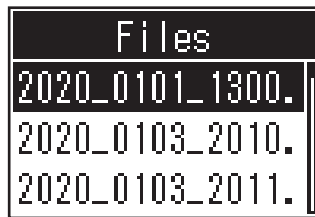

3. Use / to select the file you want to delete, and press .



4. Use / to select **Delete**, and press .



5. Use / to select **Execute**, and press .



The selected File will be deleted, and the Files Screen will reopen.

Select **Cancel** to cancel deletion.

Transferring files to a computer, smartphone or tablet

The input signals of each channel, the sounds played by pressing the SOUND PAD buttons and the master channel signal are recorded into separate files. Various editing functions can be used on them after recording by transferring them to a computer or other device. For example, their mix balance can be adjusted, effects can be added, and lengths can be changed.

Transferring files to a computer, smartphone or tablet

Recorded files can be transferred to computers, smartphones and tablets.

1. Press .

This opens the Menu Screen.

2. Use  /  to select **File Transfer**, and press .

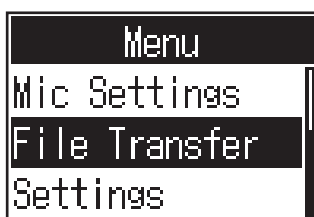

This opens the File Transfer Screen.

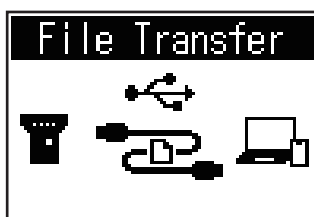

3. Use a USB cable to connect the **P4** with a computer, smartphone or tablet (→ [“Connecting a computer, smartphone or tablet by USB”](#) on page 22).
4. Use the computer to transfer the necessary files.

NOTE

When the File Transfer Screen is open, other functions and buttons cannot be used.

P4 folder and file structure

When recording with the **P4**, folders and files are created on SD cards in the following manner.

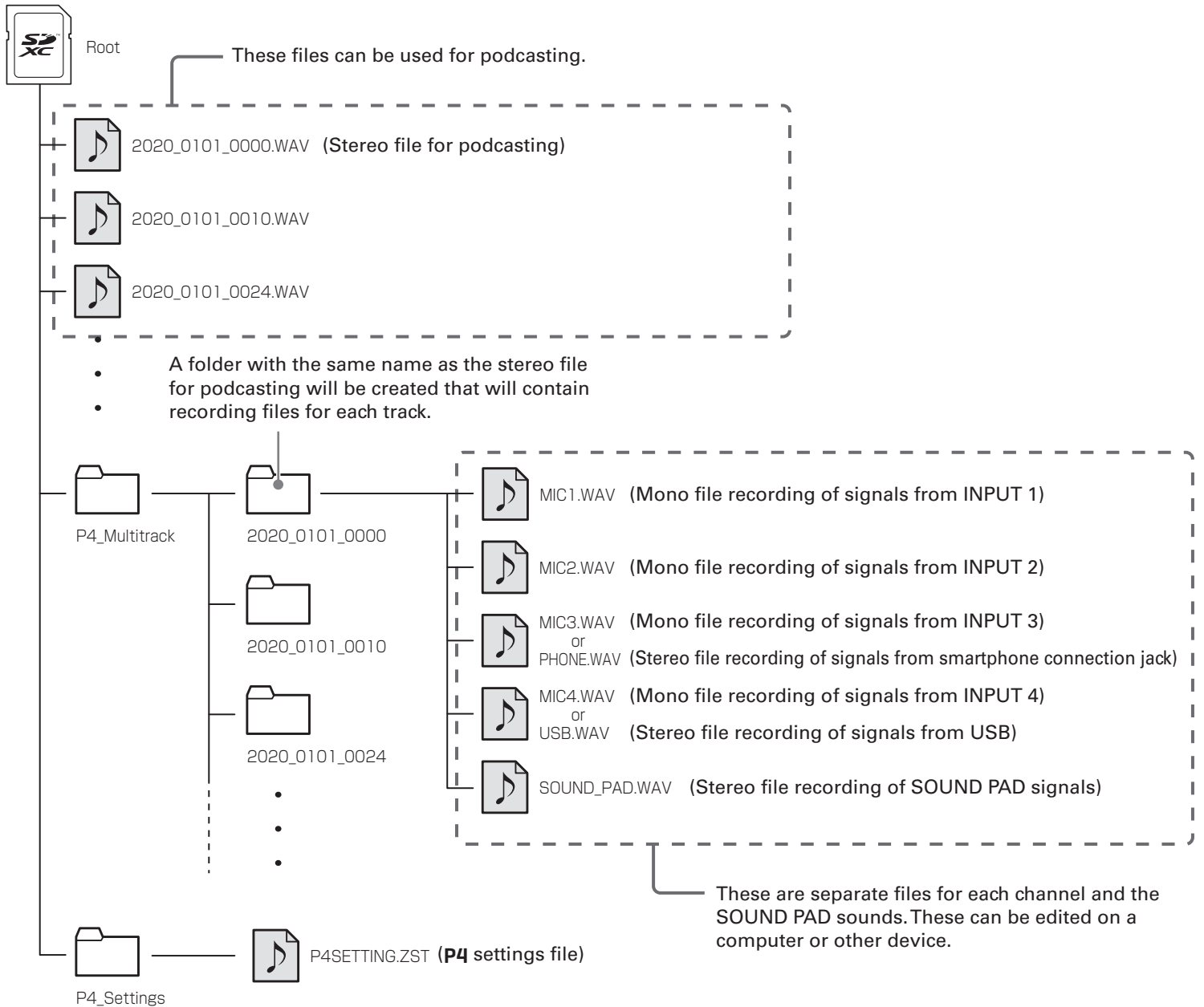

Using SOUND PAD functions

Audio files can be assigned to the SOUND PAD buttons. Press one to play the assigned file. These are convenient to play opening and closing music, jingles, and interviews that have been recorded in advance.

The level and playback method can be set for each pad.

Assigning audio files to SOUND PAD buttons

Built-in sounds and audio files saved on an SD card can be assigned to SOUND PAD buttons. Use a computer beforehand to store the audio file on the card in any directory other than the P4_Multitrack and P4_Settings folders. (→ [“Transferring files to a computer, smartphone or tablet” on page 31](#))

The following audio file types are supported.

- File format: WAV
- Sample rate: 44.1 kHz
- Bit rate: 16-bit

NOTE





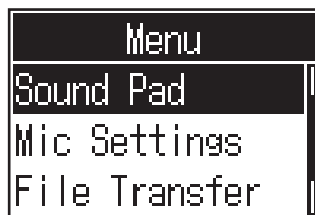

A pop-up will appear if an unsupported audio file type is selected. In this case, see [“Selecting files not supported by the P4” on page 28](#).

1. Press .

This opens the Menu Screen.

2. Use  /  to select **Sound Pad**, and press .



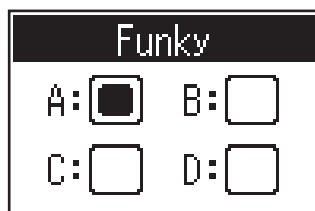

3. Use  /  (or press SOUND PAD , ,  or ) to select the SOUND PAD (A–D) for audio file assignment, and press .

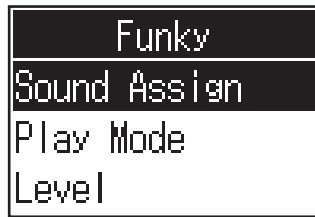

4. Use  /  to select **Sound Assign**, and press .



The built-in sound sources and the audio files stored on the SD card are shown in the list.

5. Use  /  to select the audio file to assign, and press .

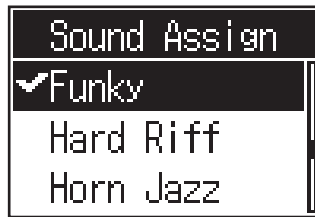

This assigns the selected file to the SOUND PAD selected in step 3.

Playing SOUND PAD buttons

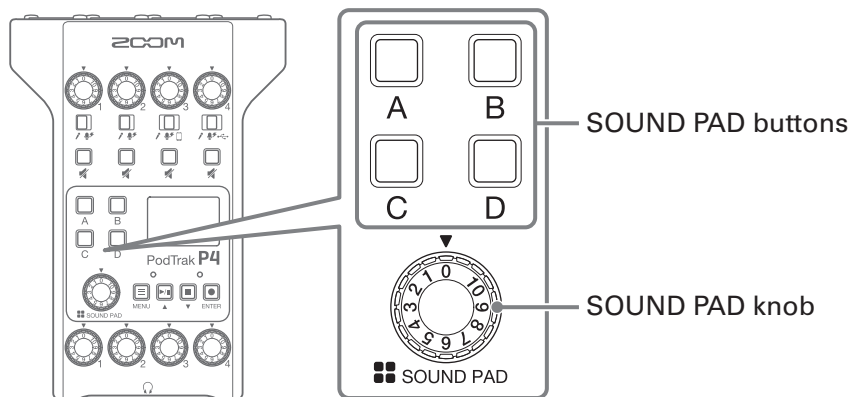

1. Press , ,  or .

This plays the audio file assigned to the pressed SOUND PAD.

When a SOUND PAD button is played, the file name will be shown on the display for two seconds after playback starts.

When a SOUND PAD is playing back, that button will blink.

2. Turn  to adjust the level.

Setting playback methods for each SOUND PAD





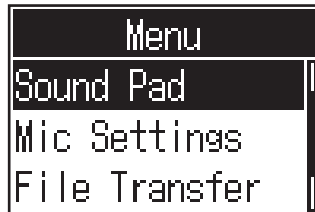

The sound playback method used when each SOUND PAD is pressed can be set.

1. Press .

This opens the Menu Screen.

2. Use / to select **Sound Pad**, and press .



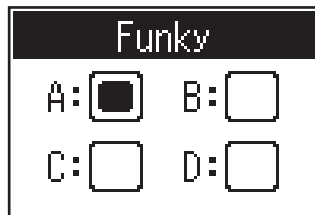

3. Use / (or press SOUND PAD , ,  or ) to select the SOUND PAD (A–D) for playback mode setting, and press .

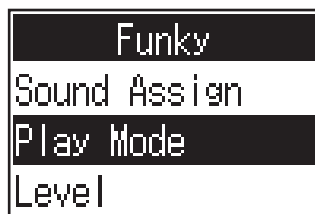

4. Use / to select **Play Mode**, and press .



5. Use  /  to select the setting, and press .

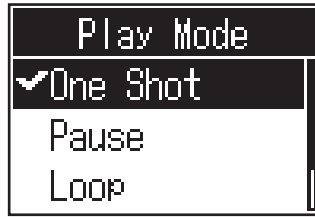

Setting	Explanation
One Shot	Each press plays the file once from beginning to end. This is useful for playing jingle and effect sounds, for example.
Pause	Each press alternately plays and pauses. Playback stops at the end of the file. Press and hold (for 2 seconds) when paused to return to the beginning of the file. This is useful for interrupting to add commentary during SOUND PAD playback.
Loop	Each press alternately plays and stops. Playback will loop until stopped. This is useful for playing background music, for example.
Hold	While pressing, loop playback will continue. When released, playback will stop. This is useful for playing effects at will for the desired lengths of time.

Adjusting the levels of each SOUND PAD

The playback levels can be adjusted separately for each SOUND PAD.





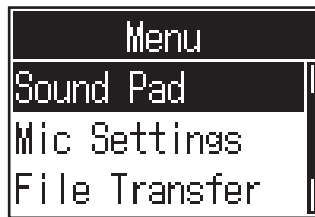

If the SOUND PAD levels differ significantly, they can be made more consistent.

1. Press .



This opens the Menu Screen.

2. Use  /  to select **Sound Pad**, and press .



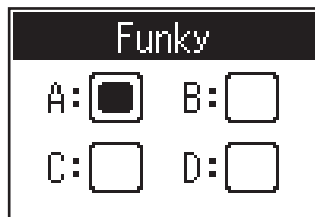

3. Use  /  (or press SOUND PAD , ,  or ) to select the SOUND PAD (A–D) for level adjustment, and press .

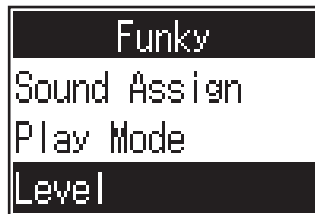

4. Use  /  to select **Level**, and press .



5. Use  /  to adjust the level, and press .

Levels can be set from -48dB – +10dB (in 30 steps).



Using as an audio interface

The **P4** can be used as a 2-in/2-out audio interface.

The following operations are possible by using the audio interface functions.

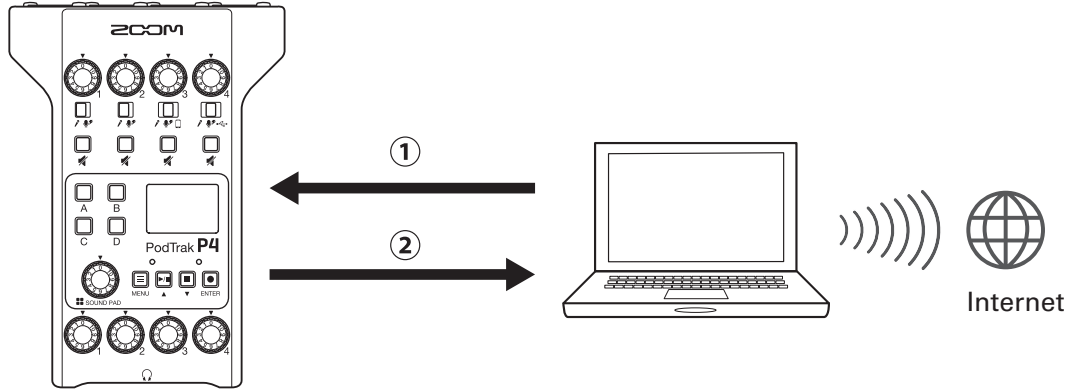

- ① Music playing or call audio on a computer, smartphone or tablet can be input on channel 4 of the **P4**.
- ② Audio input to the **P4** and audio played using SOUND PAD buttons can be sent to a computer or other device connected to the Internet and streamed in real time.

Connecting a computer, smartphone or tablet

1. Use a USB cable to connect the USB port (Type-C) to the computer, smartphone or tablet.

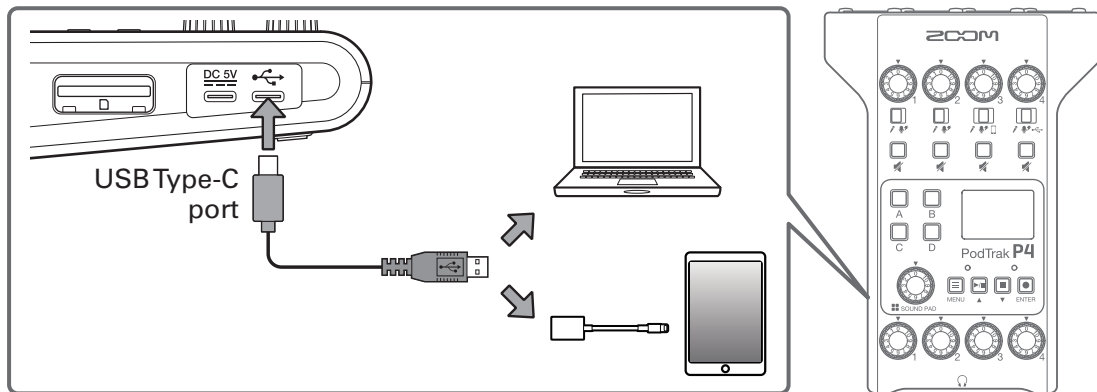

NOTE

Use a Lightning to USB Camera Adapter (or Lightning to USB 3 Camera Adapter) to connect to an iOS/iPadOS device with a lightning connector.

2. Select the **P4** as the input and output device on the connected computer or other device.

NOTE

"ZOOM P4 Audio" will appear on the computer.

Inputting USB audio return on channel 4

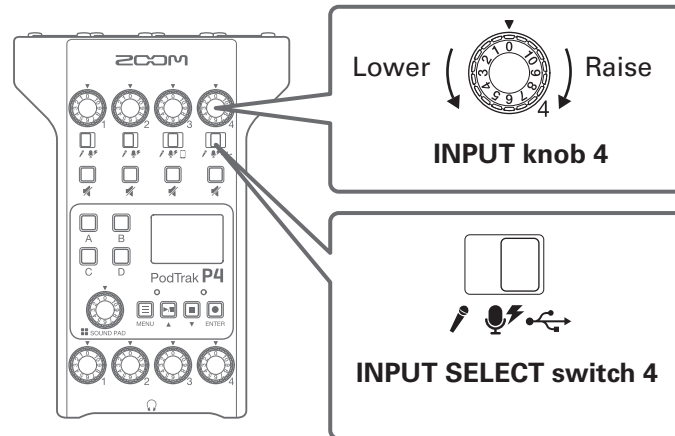

1. Set  to .

This sets the USB audio return as the signal input on channel 4.



2. Turn  to adjust the level.

Setting USB Mix Minus

When using the **P4** as an audio interface, this can prevent feedback to a person participating in a call through the connected device.

1. Press .



This opens the Menu Screen.

2. Use / to select **Settings**, and press .



3. Use / to select **USB Mix Minus**, and press .



4. Use / to select the setting, and press .

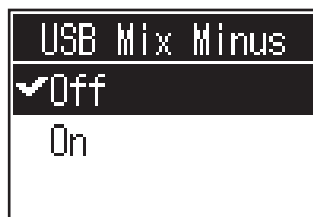

Setting	Explanation
Off	Sound from USB input is also output by USB.
On	Sound from USB input is not output by USB.

Modifying the date and time

The date and time are stored in recorded files, and the recording start date/time is used in the file name. Having the correct date and time set is helpful when looking for files, for example, by allowing contents to be determined by names.

1. Press .

This opens the Menu Screen.

2. Use / to select **Settings**, and press .

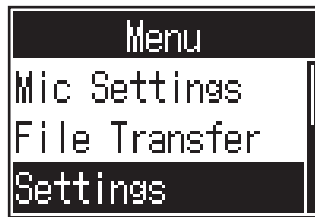



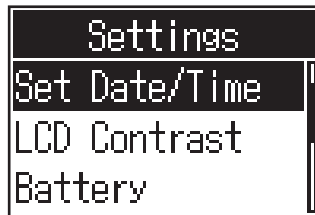

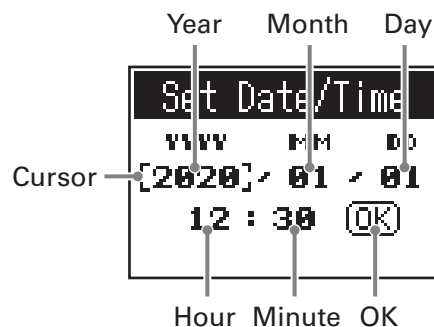

3. Use / to select **Set Date/Time** and press .



4. Setting the date and time.



1. Press / to move the cursor to set, and press .

2. Use / to change the value, and press  to confirm.

3. Repeat steps 1 and 2 to set the date and time.

4. After setting the date and time, use / to select OK, and press . Confirm the set date and time.

Setting the type of batteries used



Set the type of battery used correctly so that the amount of remaining battery charge can be shown accurately.

1. Press .

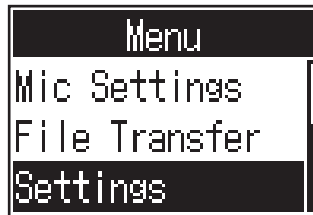

This opens the Menu Screen.

2. Use / to select **Settings**, and press .

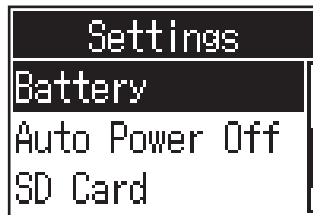

3. Use / to select **Battery**, and press .



4. Use / to select the setting, and press .

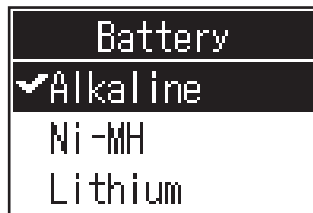



Setting	Explanation
Alkaline	Alkaline batteries
Ni-MH	Nickel-metal hydride batteries
Lithium	Lithium batteries

Adjusting the display contrast

Adjust the contrast if the display is difficult to read because it appears too light or dark.

1. Press .

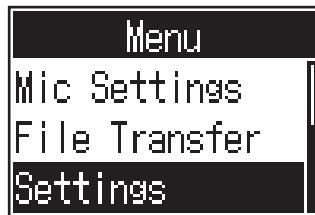

This opens the Menu Screen.

2. Use / to select **Settings**, and press .

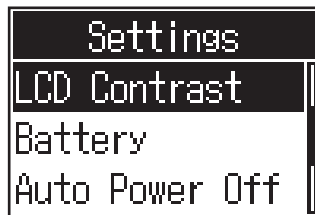

3. Use / to select **LCD Contrast**, and press .



4. Use / to select the setting value, and press .



HINT

This can be set from 1 to 10.

Setting the Auto Power Off function

The power will automatically turn off if the **P4** is unused for 10 hours.



To keep the power on at all times, set the Auto Power Off function to **Off**.

1. Press .

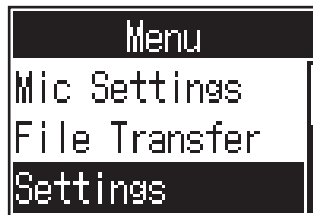

This opens the Menu Screen.

2. Use / to select **Settings**, and press .

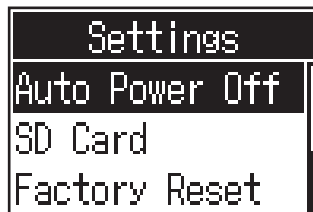

3. Use / to select **Auto Power Off**, and press .



4. Use / to select the setting, and press .

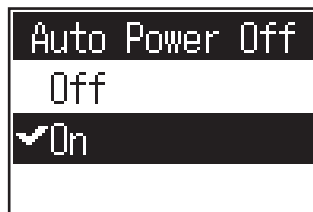

Setting	Explanation
On	The power will automatically turn off if it is not used for 10 hours.
Off	The power will not turn off automatically.

Testing SD cards

SD cards can be tested to confirm whether they can be used with the **P4**.



A basic test can be done quickly, while a full test examines the entire SD card.

Conducting a quick test

1. Press .

MENU

This opens the Menu Screen.

2. Use / to select **Settings**, and press .

ENTER

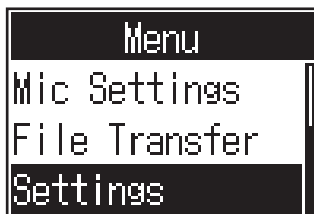

3. Use / to select **SD Card**, and press .

ENTER

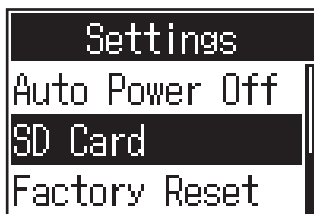

4. Use / to select **Card Test**, and press .

ENTER

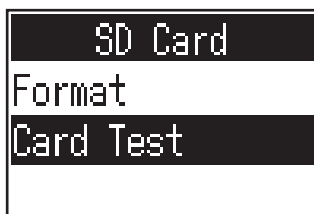

5. Use  /  to select **Quick Test**, and press .

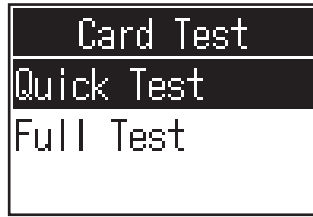

6. Use  /  to select **Execute**, and press .

The card performance test will start. The test should take about 30 seconds.

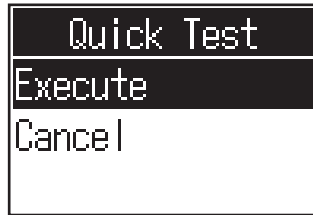

The result of the test will be shown when it completes.

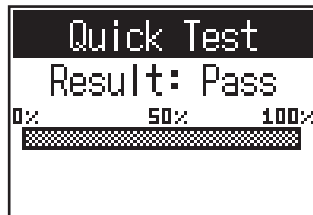

NOTE

Even if a performance test result is "Pass", there is no guarantee that writing errors will not occur. This information is just to provide guidance.

HINT

Press  to cancel a test while it is being executed.



Conducting a full test

1. Press .

This opens the Menu Screen.

2. Use / to select **Settings**, and press .



3. Use / to select **SD Card**, and press .

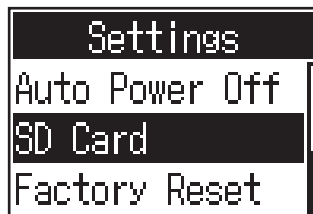

4. Use / to select **Card Test**, and press .

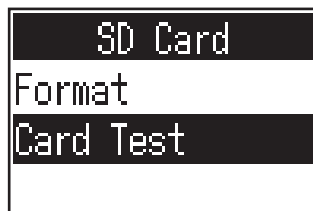

5. Use / to select **Full Test**, and press .

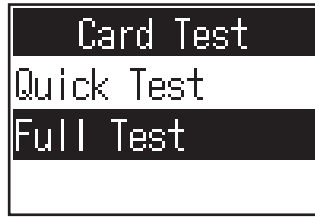

The amount of time required will be shown.

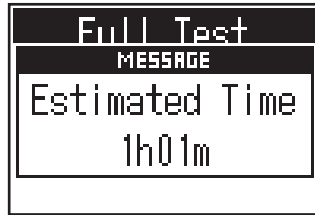

6. Use / to select **Execute**, and press .

The card performance test will start.

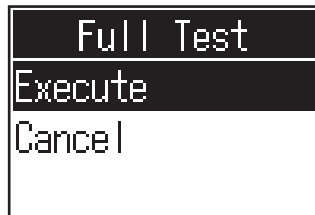

The result of the test will be shown when it completes.

If the access rate MAX reaches 100%, the card will fail (NG).

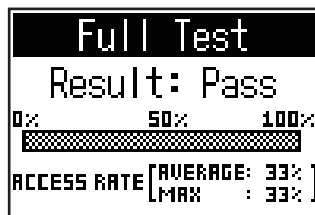

NOTE

Even if a performance test result is "Pass", there is no guarantee that writing errors will not occur. This information is just to provide guidance.

HINT

Press  to cancel a test while it is being executed.

Formatting SD cards

Format SD cards for the **P4** to maximize their performance.



Before using SD cards that have just been purchased or that have been formatted on a computer, they must be formatted by the **P4**. Be aware that formatting an SD card will delete all data, including files assigned to SOUND PAD buttons, on it.

1. Press .

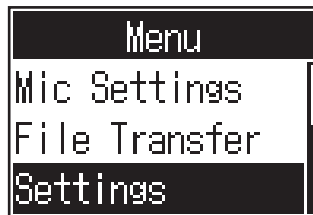

This opens the Menu Screen.

2. Use / to select **Settings**, and press .

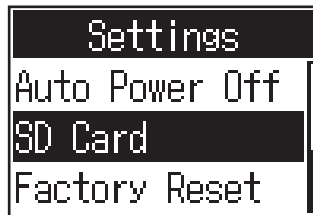

3. Use / to select **SD Card**, and press .



4. Use / to select **Format**, and press .

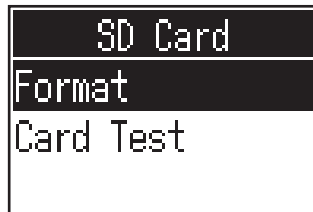

5. Use / to select **Execute**, and press .

This formats the card.

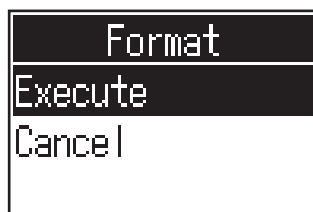

Restoring factory default settings



The **P4** can be restored to its factory default settings.

1. Press .

This opens the Menu Screen.

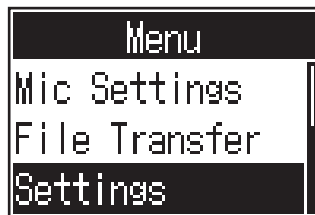
2. Use / to select **Settings**, and press .



3. Use / to select **Factory Reset**, and press .

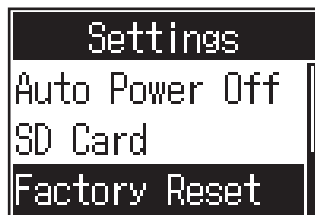

4. Use / to select **Execute**, and press .

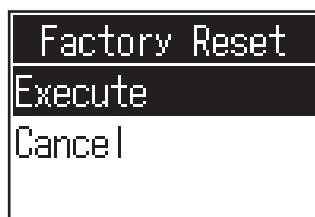

This restores the **P4** to its factory default settings, and its power turns off.

NOTE

A factory reset will overwrite all settings to their factory defaults. Be certain before using this function.

Updating the firmware

The **P4** firmware can be updated to the latest version.

Files for the latest firmware updates can be downloaded from the ZOOM website (zoomcorp.com).

Follow the instructions in the “P4 Firmware Update Guide” on the **P4** download page.

Error message list

This is a list of error messages that could pop up on the display. Respond as described below when necessary.



Pop-up message	Explanation
Read Only!	The file is set to be read only. → Use a computer to unlock the read only status of the file.
Choose 16-bit or 24-bit File!	Select a file that is 16-bit or 24-bit. → The P4 does not support playback or conversion of the file.
Choose Mono or Stereo File!	Select a mono or stereo file. → The P4 does not support playback or conversion of the file.
Choose 44.1kHz or 48kHz File!	Select a file that has a 44.1 kHz or 48 kHz sample rate. → The P4 does not support playback or conversion of the file.
Choose WAV or MP3 File!	Select a file that uses WAV or MP3 format. → The P4 does not support playback or conversion of the file.
File Convert. 48kHz->44.1kHz	This file requires sample rate conversion. → Convert to a file that is supported by the P4 .
File Convert. 24-bit->16-bit	This file requires bit rate conversion. → Convert to a file that is supported by the P4 .
File Convert. MP3->WAV	This file requires file format conversion. → Convert to a file that is supported by the P4 .
Invalid File!	This file is damaged or invalid. → Select a good file.
Card Full!	The SD card has no more open space. → Delete unnecessary files (→ “Deleting files” on page 30), or use a different SD card.
File Name Already Exists!	A file with the same name already exists. → Change the file name. (→ “Changing the names of recorded files” on page 29)
Input File Name!	Input the file name. → Input the file name. (→ “Changing the names of recorded files” on page 29)
Character Limit Reached!	The maximum number of characters has been exceeded. → Reduce the number of characters.
Card Error!	An error occurred with the SD card. → See “Troubleshooting” on page 54 .
No Card!	No SD card is loaded. → Load an SD card.
Invalid Card!	The SD card is invalid. → Load an SD card that is supported by the P4 . (→ “Troubleshooting” on page 54)
Card Protected!	SD card write-protection is enabled. → Disable write-protection.
Low Battery!	The remaining battery charge has become low. → Install new batteries or supply power by connecting an AC adapter, mobile battery or computer, for example. (→ “Providing power” on page 15)
Date/Time Reset!	The date and time setting has been reset. → Set the date and time again. (→ “Modifying the date and time” on page 41)

Pop-up message	Explanation
No Last Recorded File!	The latest recording file is not available. → This appears if the most recently recorded file does not exist when  is pressed on the Home Screen.
File Full!	The maximum number of files on an SD card has been reached. → Delete unnecessary files (→ “Deleting files” on page 30), or use a different SD card.
Now Recording!	This operation is disabled during recording. → During recording, the power cannot be turned off and the Menu Screen cannot be opened.
Write Error!	An error writing to the SD card. → See “Troubleshooting” on page 54 .
No File!	No file is available. → This appears when Files is selected on the Menu Screen if the SD card has no files.
File Assigned To Sound Pad Missing!	A file assigned to a SOUND PAD cannot be found. → Assign a file to the SOUND PAD. (→ “Assigning audio files to SOUND PAD buttons” on page 33)
Sound Pad Files Will Be Erased!	Formatting will erase files assigned to SOUND PAD. → This appears when starting to format an SD card if it contains files assigned to SOUND PAD buttons.
Setting Changes After Recording!	Phantom power setting changes will be applied after recording completes. → This appears when the INPUT SELECT switch is changed during recording.
Low Power! Please Power Off.	The remaining battery charge is insufficient. Turn the power off. → Turn the power off and install new batteries or supply power by connecting an AC adapter, mobile battery or computer, for example. (→ “Providing power” on page 15)

Troubleshooting

General

There is no sound or output is very quiet

- Check headphone connections and volumes. (→ [“Connecting headphones” on page 19](#))
- Check mic connections. (→ [“Connecting mics” on page 18](#))
- When using condenser mics, set the INPUT SELECT switches to . (→ [“Connecting mics” on page 18](#))
- Confirm that  is unlit.
- Turn the INPUT knobs for each channel to raise their levels, and confirm that their level meters are moving. (→ [“Adjusting input levels” on page 23](#))

Recorded audio is too loud, too quiet or silent

- When using condenser mics, set the INPUT SELECT switches to . (→ [“Connecting mics” on page 18](#))
- Use the channel input knobs to adjust their levels. (→ [“Adjusting input levels” on page 23](#))
- Confirm that the REC indicators are lit red.

Recording is not possible

- Confirm that the REC indicators are lit red.
- Confirm that the SD card has open space.

Proper recording is not possible/Stopping recording takes too much time

- SD cards can become worn out. Speed can decrease after repeated writing and erasing.
- Formatting the card with the **P4** might improve this. (→ [“Formatting SD cards” on page 49](#))
- If formatting an SD card does not improve this, we recommend replacing the card. Please check the list of cards that have been confirmed to work on the ZOOM website.

NOTE

This is not a guarantee of specific SD card recording performance for SDHC/SDXC cards that have been confirmed to work. This list is provided as a guideline to help find suitable cards.

Playback sound cannot be heard or is quiet

- Turn the PHONES knobs to adjust their volumes. (→ [“Connecting headphones” on page 19](#))

Audio files cannot be assigned to SOUND PAD buttons

- Check the format of the audio file to be assigned. (→ [“Assigning audio files to SOUND PAD buttons” on page 33](#))
- If the audio file is stored on an SD card, store it in a directory outside the P4_Multitrack and P4_Settings folders on the card.

SOUND PAD functions cannot be used

- Check the SOUND PAD levels. (→ [“Playing SOUND PAD buttons” on page 34](#))
- Confirm that files are assigned. (→ [“Assigning audio files to SOUND PAD buttons” on page 33](#))

Audio interface

Cannot select the P4 from a computer, smartphone or tablet (or cannot use it as an interface)

- Confirm that the **P4** is connected to the computer correctly. (→ [“Connecting a computer, smartphone or tablet by USB” on page 22](#))
- Quit all the software that is connected to the **P4**, and turn the **P4** off and on again.
- Connect the **P4** directly to a USB port on the computer or other device. Do not connect it through a USB hub.

Sound skips during playback or recording

- If the audio buffer size of the software being used can be adjusted, increase the buffer size.
- Connect the **P4** directly to a USB port on the computer or other device. Do not connect it through a USB hub.
- Turn off power saving settings (including sleep functions) on the computer or other device.

Cannot play or record

- Confirm that the **P4** is connected to the computer correctly. (→ [“Connecting a computer, smartphone or tablet by USB” on page 22](#))
- Confirm that the **P4** is selected in the settings of the computer being used.
- Confirm that **P4** is set for input and output in the software that you are using.
- Set INPUT SELECT switch 4 to .
- Quit all the software that is connected to the **P4**, and disconnect and reconnect the USB cable connected to the **P4**.

Specifications

Number of input and output channels	Number of input channels	4 (mono/stereo)	
	Number of output channels	1 (headphone × 4)	
Connectors	MIC	Type	XLR jack (2: HOT)
		Input gain	-∞ – +70 dB
		Input impedance	XLR: 3 kΩ
		Maximum input level	0 dBu (at 0 dBFS)
		Phantom power	+48 V
	Smartphone connection jack	Type	TRRS mini jack (4-contact; TIP: L, RING: R, RING: GND, SLEEVE: MIC)
		Input impedance	3 kΩ
		Maximum input level	+3 dBu
	Headphones	Type	3.5 mm stereo mini
		Maximum output level	20 mW + 20 mW (32 Ω load)
		Output impedance	10 Ω
	USB	USB Type-C (audio interface and mass storage functions) Note: Use a USB cable that supports data transfer. USB bus power is supported.	
	DC 5 V	USB Type-C (for power supply)	
Recorder	Format	WAV 44.1 kHz, 16-bit, mono/stereo	
	Recording media	4 GB – 32 GB SDHC-compliant cards (Class 10 or higher) 64 GB – 512 GB SDXC-compliant cards (Class 10 or higher)	
Audio interface	44.1 kHz, 16-bit, 2-in/2-out		
Frequency response	-1.0 dB: 20 Hz – 20 kHz (at 44.1 kHz sampling rate)		
Equivalent input noise	-124 dBu or less (IHF-A) with +70 dB/150 Ω input		
Display	LCD with backlight (96×64 resolution)		
Power supply	2 AA batteries (alkaline, nickel-metal hydride or lithium) • We recommend nickel-metal hydride batteries for the P4. AC adapter (ZOOM AD-17): DC 5 V/1 A (supports USB bus power)		
Estimated continuous operation time using batteries	Recording 44.1 kHz/16-bit 4ch audio to an SD card (+48 V OFF, headphones into 63 Ω load) Alkaline batteries: about 3 hours NiMH batteries (1900 mAh): about 3.5 hours Lithium batteries: about 8 hours • The above values are approximate. • Continuous battery operation times were determined using in-house testing methods. They will vary greatly according to use conditions.		
Power consumption	5 W		
External dimensions	112 mm (W) × 155 mm (D) × 47 mm (H)		
Weight (unit only)	290 g		

Note: 0 dBu = 0.775 V



ZOOM CORPORATION

4-4-3 Kanda-surugadai, Chiyoda-ku, Tokyo 101-0062 Japan
zoomcorp.com